

11a CAMEL ARKUSZ 1

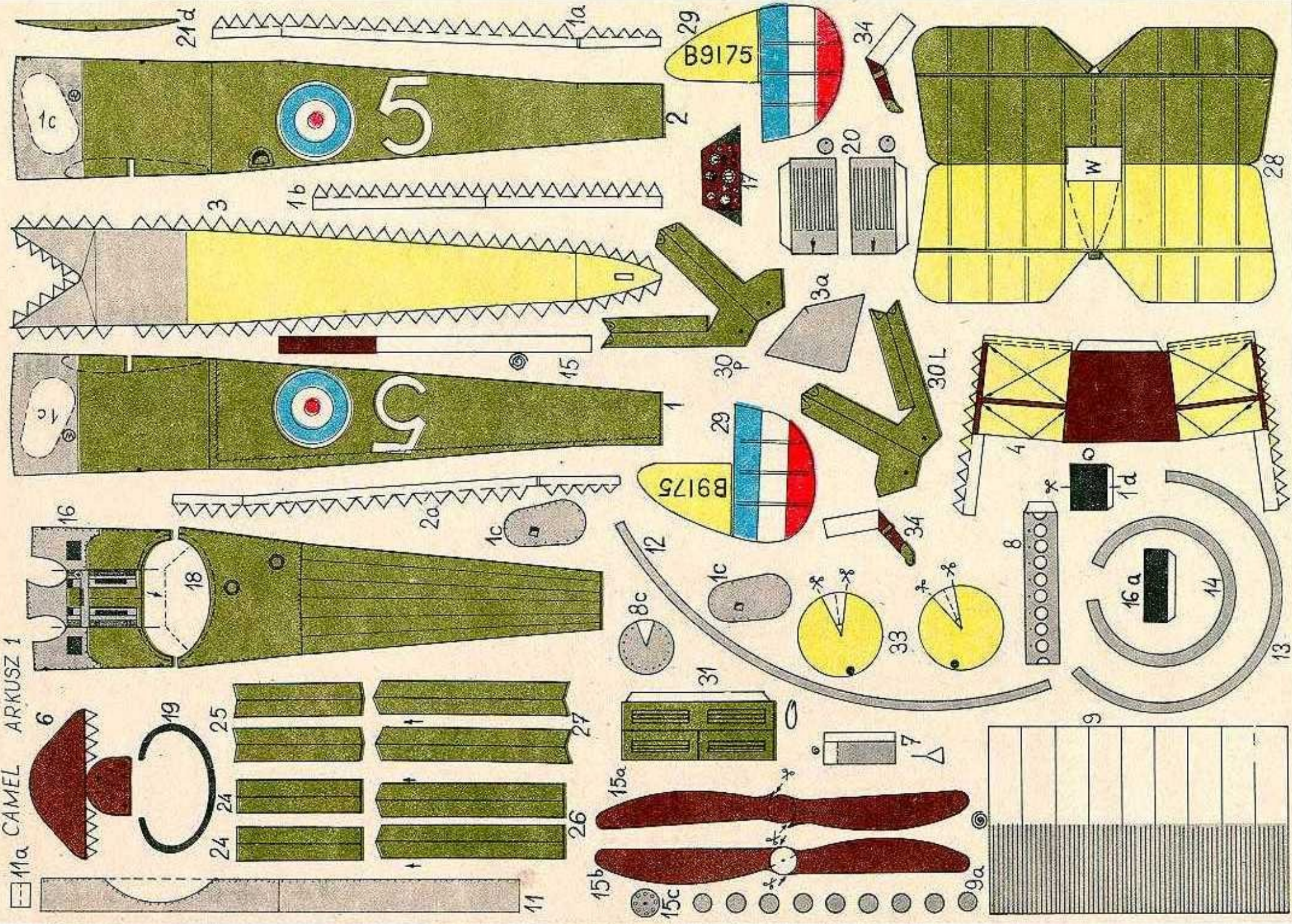

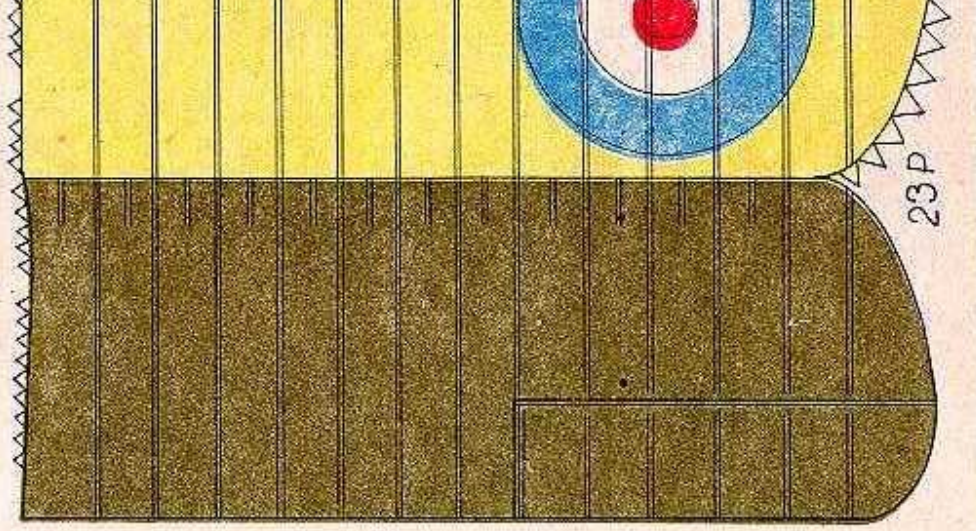

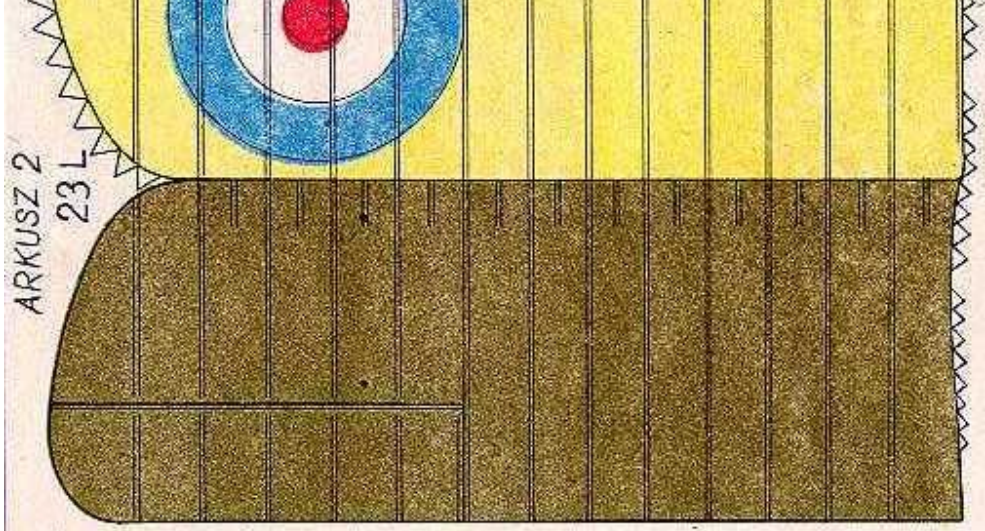
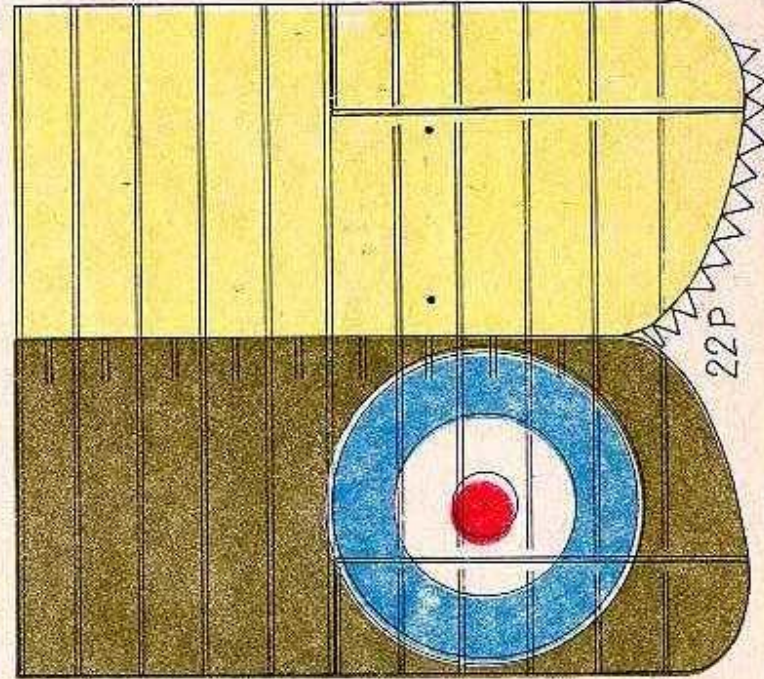
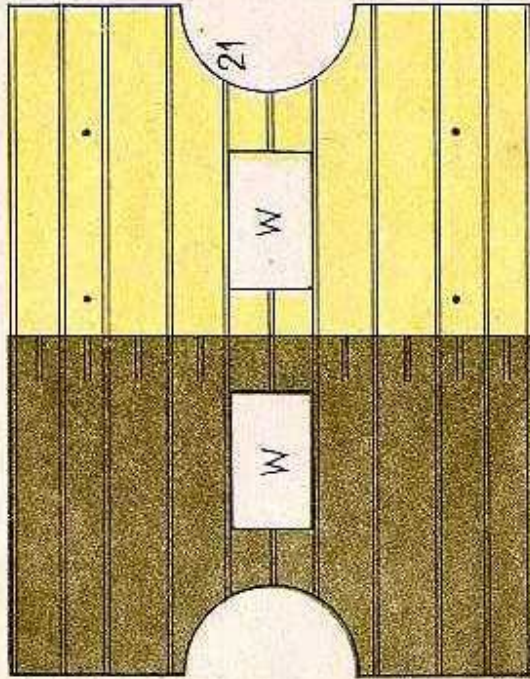
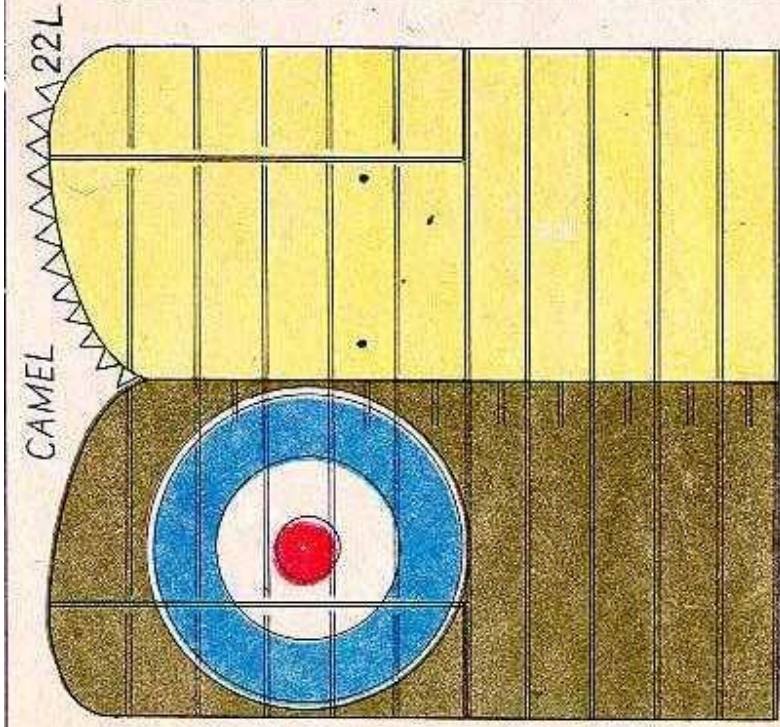
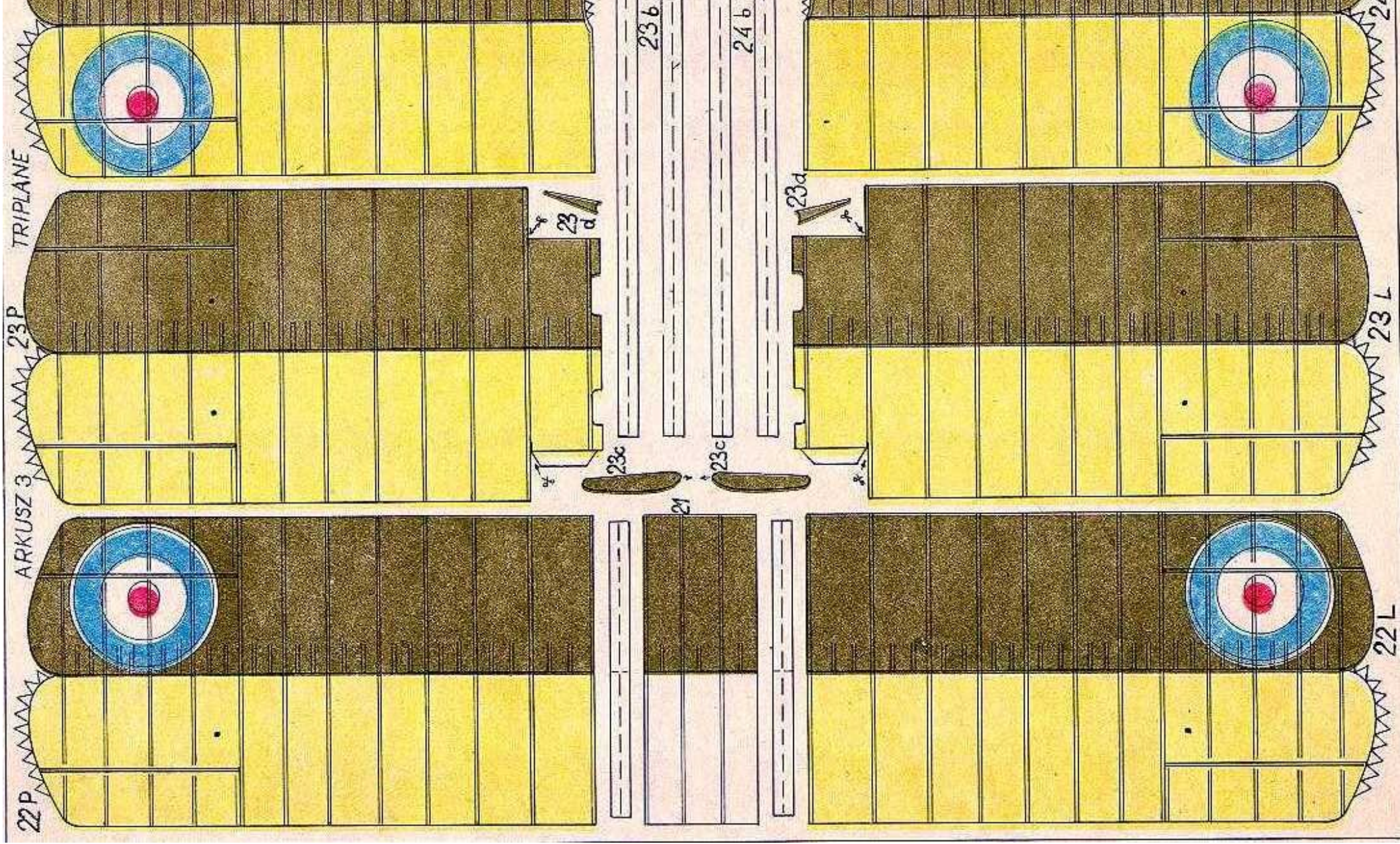

ARKUSZ 4

TRIPLANE

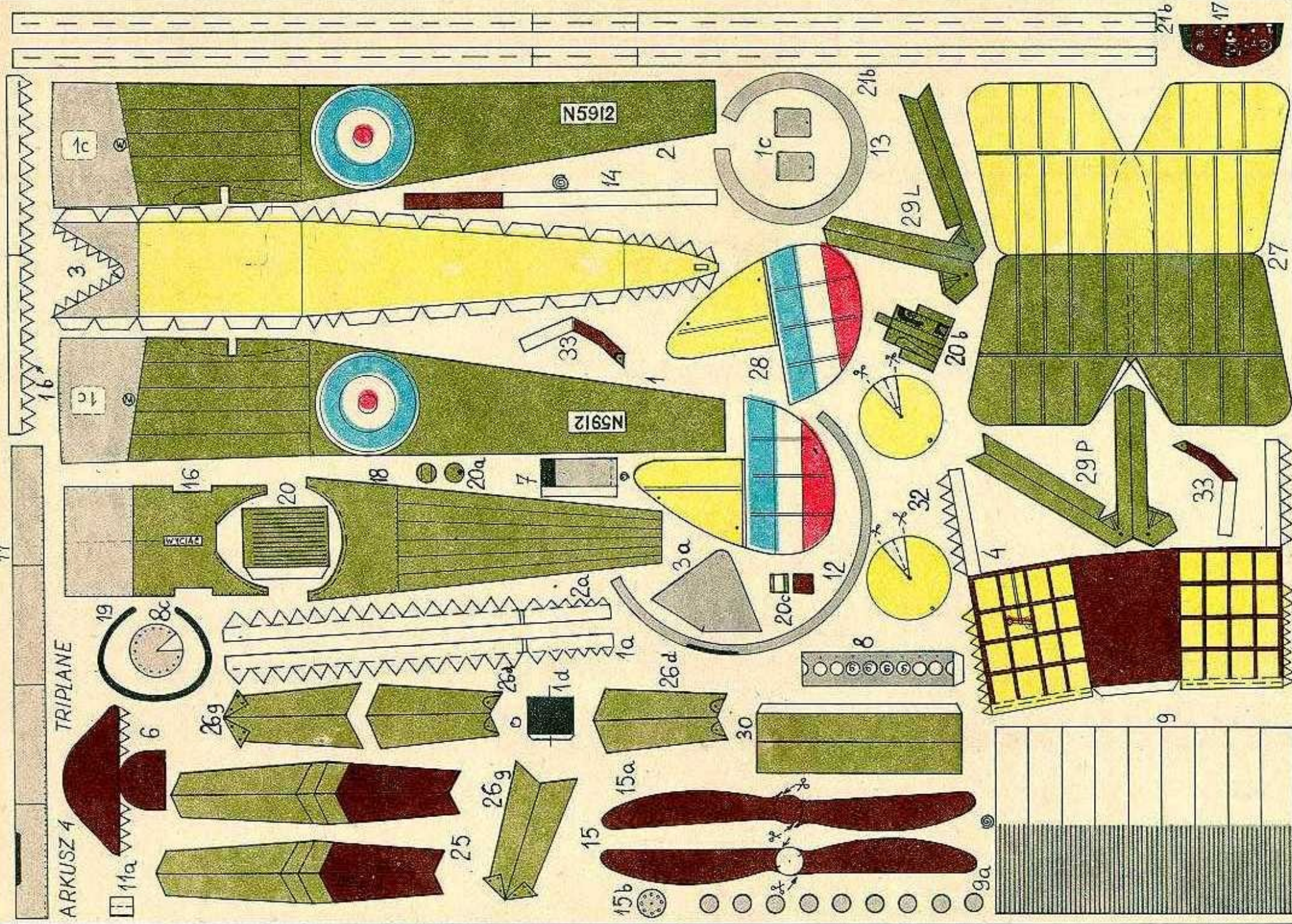

N5912

N5912

WYCIĄG

11a

19

6

26g

8c

20

16

18

20a

7

26a

1d

26b

26c

1a

26d

30

8

20c

12

32

4

33

29P

33

29L

20b

13

21b

27

17

15

15a

15b

9a

9

9

9

9

9

9

9

9

9

9

9

9

9

9

9

ARKUSZ 5

CAMEL

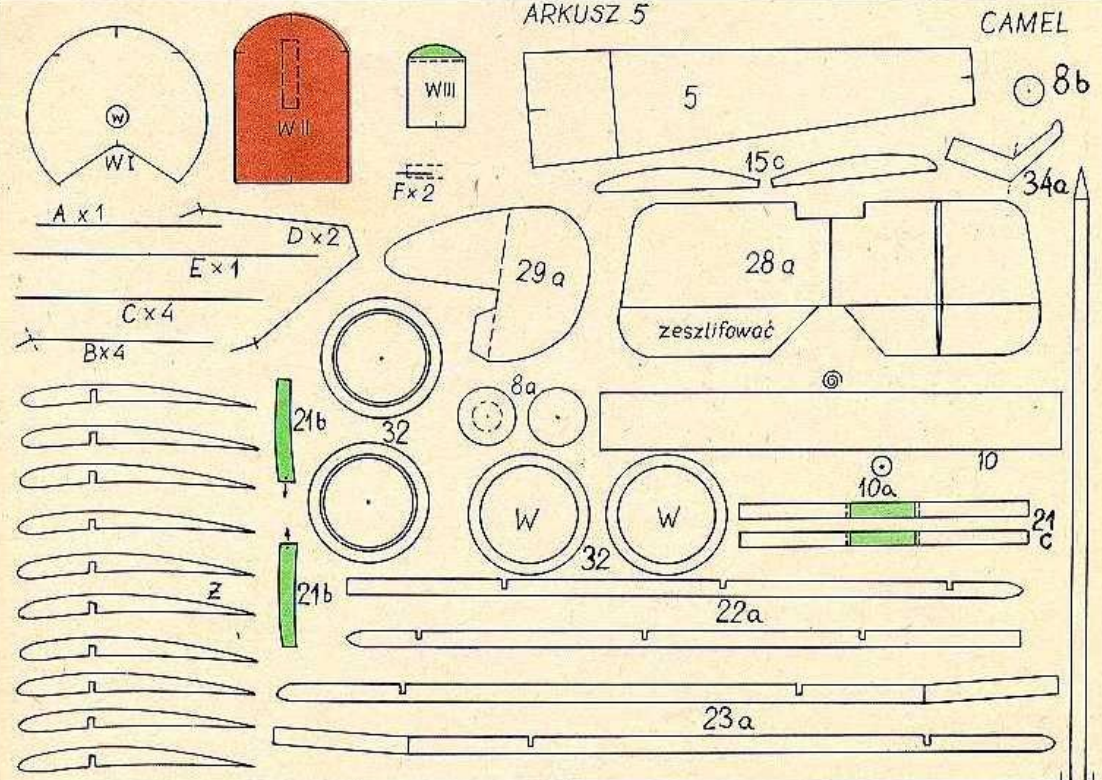

TRIPLANE

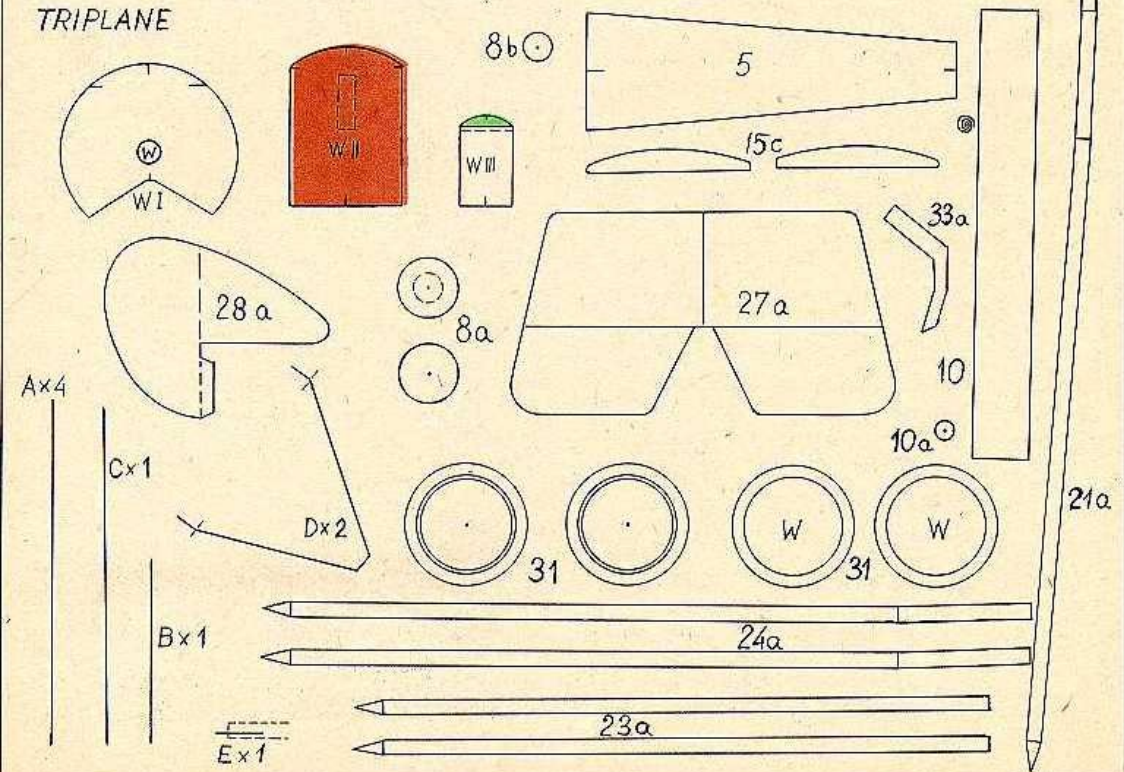

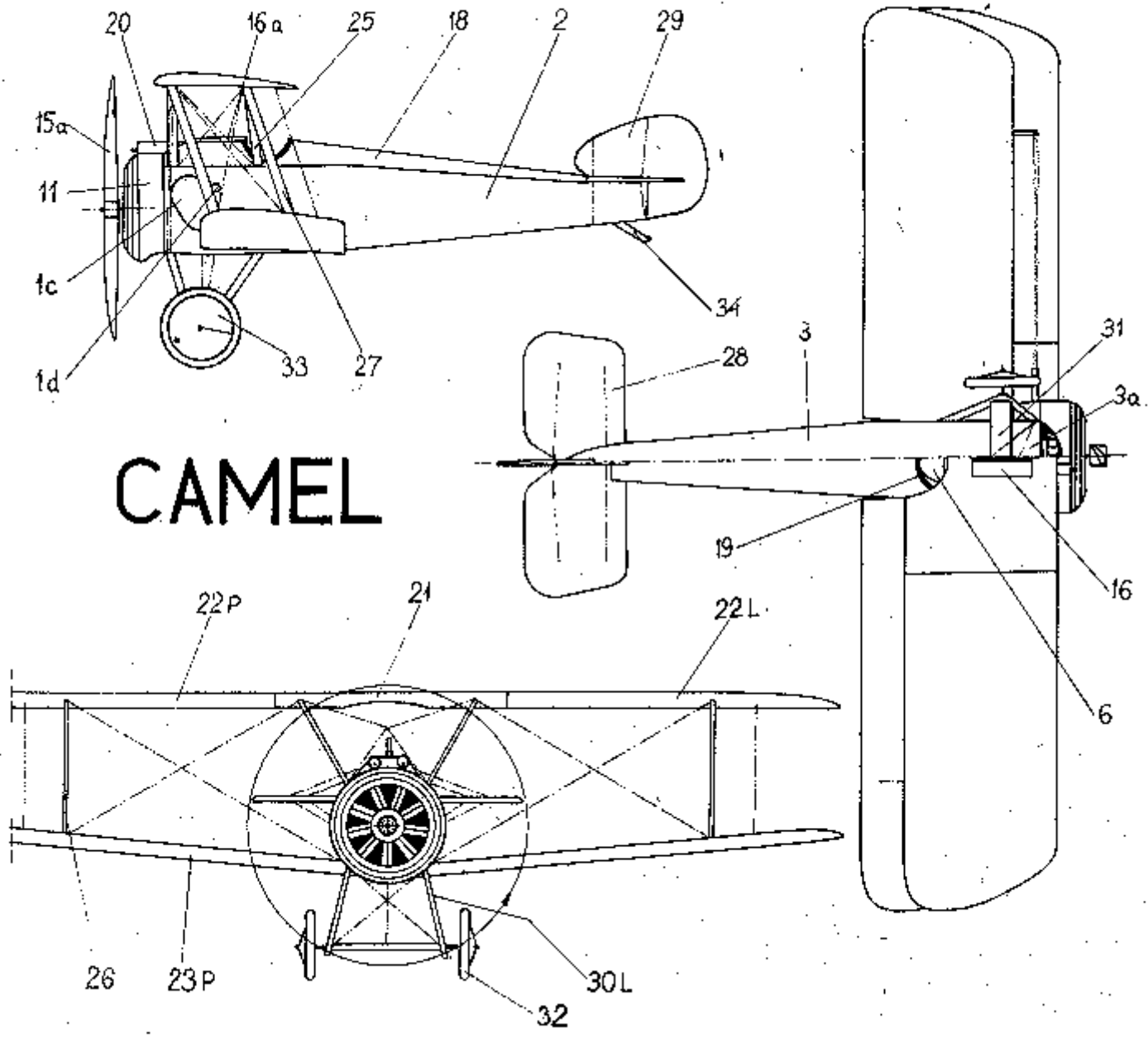

CAMEL

TRIPLANE

